



ROTARY SHAFT OIL SEALS TYPE G and M

The rotary shaft oil seal is an indispensable component in any lubricated rotating equipment. The FP oil seals provide the right solution to every sealing problem.

FP rotary shaft oil seals are produced according to modern engineering techniques with high-performing materials, as requested by industry specifications.

G

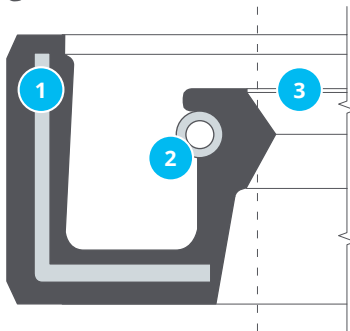

Technical features

- 1 Metal body covered with elastomer
- 2 Garter spring
- 3 Sealing edge made through cutting process

Materials

- 1 Metal body: DC04; AISI 304; AISI 316
- 2 Garter spring: AISI 302; AISI 316; C72 phosphated
- 3 Elastomer: NBR; FKM; VMQ; HNBR; EPDM

G and M TYPES

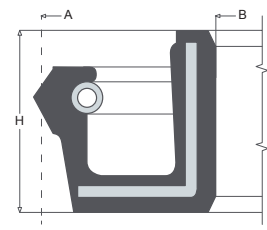
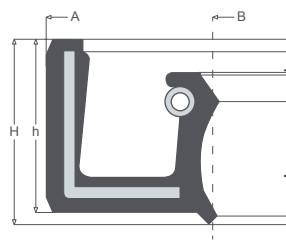
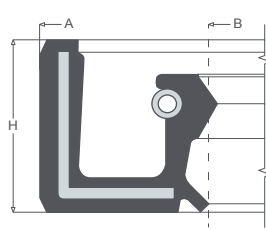
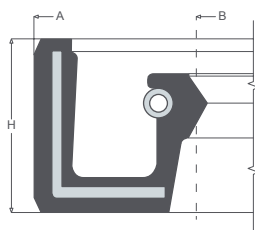

G

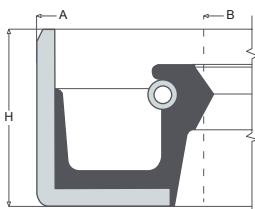

GP

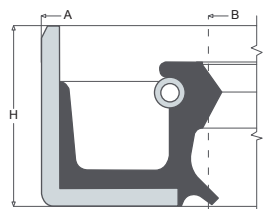

GPA

Rotary shaft oil seals in rubber-to-metal produced according to DIN3760 norm. Supplied with rubber or with metal outer diameter.

GTE

The sealing lip is obtained by cutting process to avoid imperfection, and energize with a garter spring.

M

MP

For further information on all our seals, please check our web page or contact our offices.

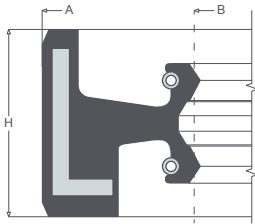

G2

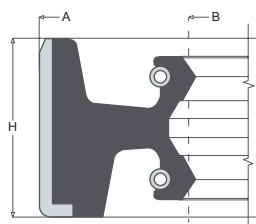

M2

Double lip oil seal with two garter springs, to provide a compact sealing in housings with

limited space, and from two different fluids.

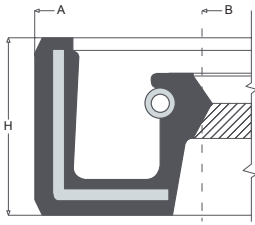

GZS

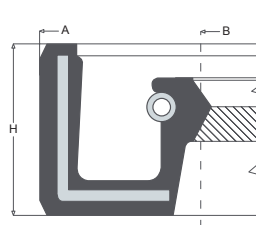

GZD

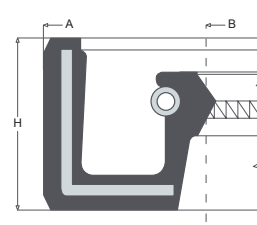

GZT

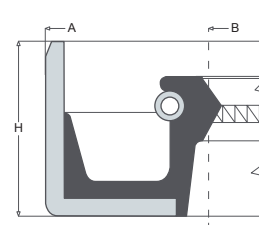

MZT

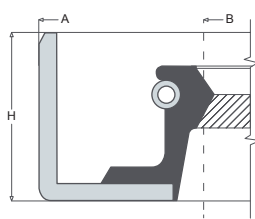

MZS

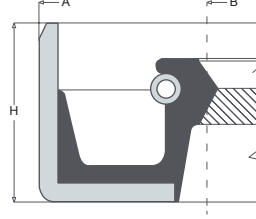

MZD

Oil seals with conical groove on the internal surface of the lip. Usually used in the automotive industry, and particularly for driving shafts. The groove to the right (D) or to the left (S) limits the use of the seals to one direction.

The same groove is available also on oil seals with dust lips (Types GPZS, GPZD, MPZS, MPZD). The profiles GZT and MZT are produced with a bidirectional groove on the inner sealing lip, for alternative directions.

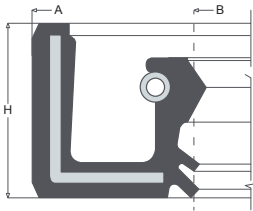

GPP

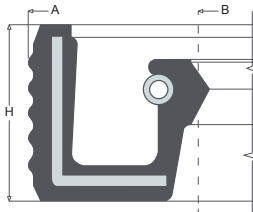

GRE

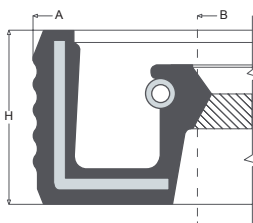

GZDRE

The suffix RE indicates the outer sealing groove profile, which is used to compensate possible imperfections of the housing. These seals are normally used with pressed or non-ground housing surfaces.

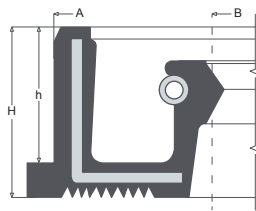

GF

Rotary shaft oil seals with special performances produced for non-standard applications. The GPP type includes a double dust lip, while the GF type has a flange on the outer diameter.

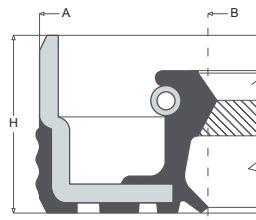

MGPZD

The letters M & G together illustrate a metal outer diameter partially covered with elastomer. This type of seal is used for maintenance purposes, while replacing rings with a metal outer diameter (type M). Once the original ring is re-

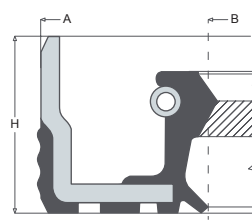

MGPZS

placed, the housing may reveal damages caused by removing the ring. The partial rubber covering of the MG type provides the static sealing of the new ring even in housing with those impairments.